

REV.	DATE	ECO	DESCRIPTION	BY	CK	APP
-	10/11/19	N/A	INITIAL RELEASE	GDR	N/A	N/A

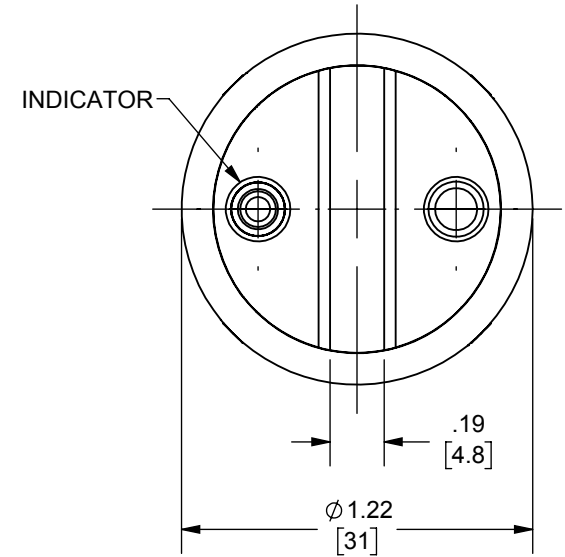

DIMENSIONS IN [ ] ARE MILLIMETERS

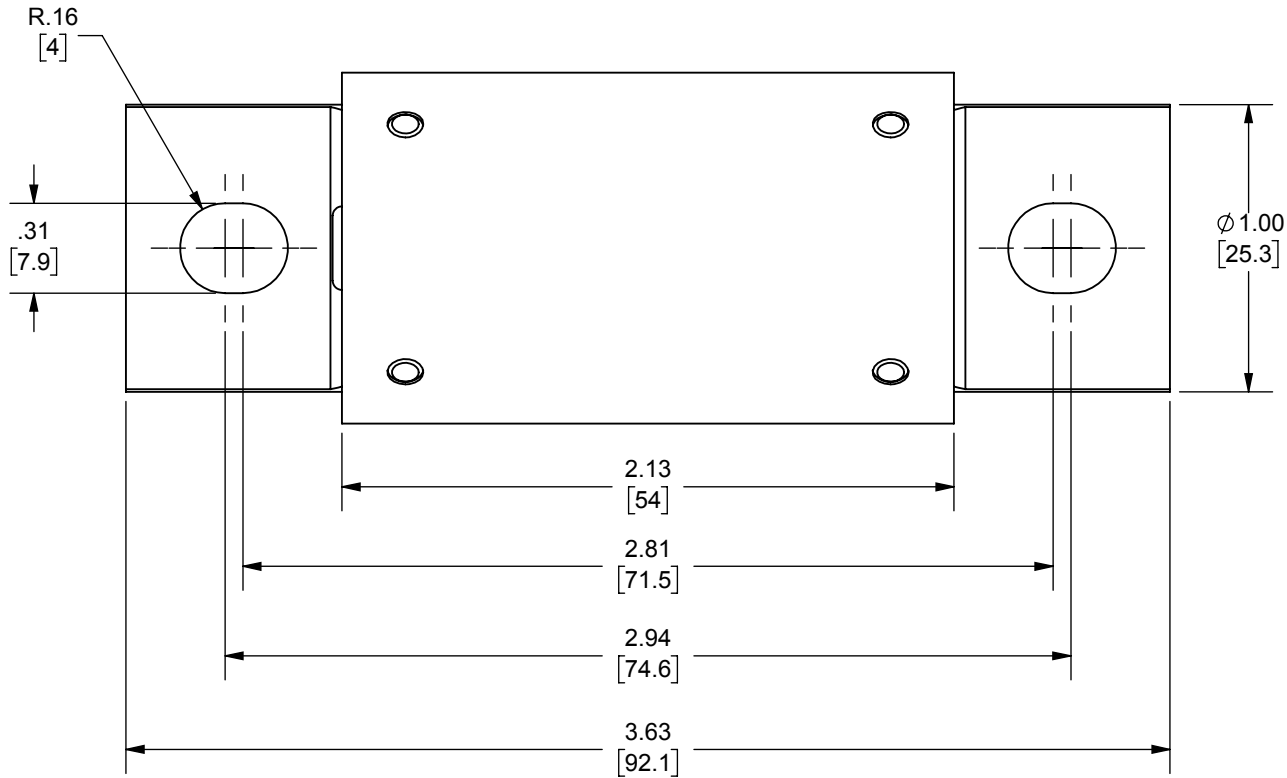

MERSEN USA NEWBURYPORT-MA, LLC  
374 MERRIMAC STREET  
NEWBURYPORT, MA 01950

A50P(125-200)-4TI

FORM 101 TYPE 4TI

125A-200A 500V

OUTLINE DIMENSIONS  
NOT TO BE USED FOR PRODUCTION

702289

PRODUCT MANAGER

SIGN: YICHI AU

DATE: 10/16/19

DESIGN ENGINEER

SIGN: K.HORNE

DATE: 10/16/19