

REV.	DATE	ECO	DESCRIPTION	BY	CK	APP
-	9/25/2013	N/A	INITIAL RELEASE	GDR	N/A	N/A

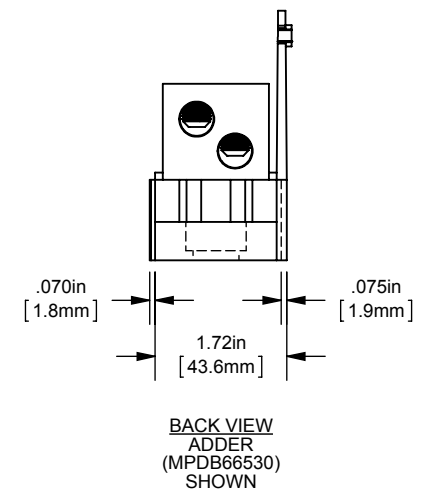

DIMENSIONS IN [] ARE MILLIMETERS

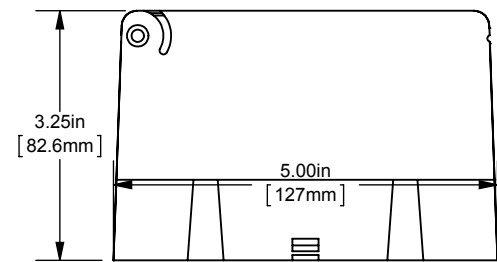
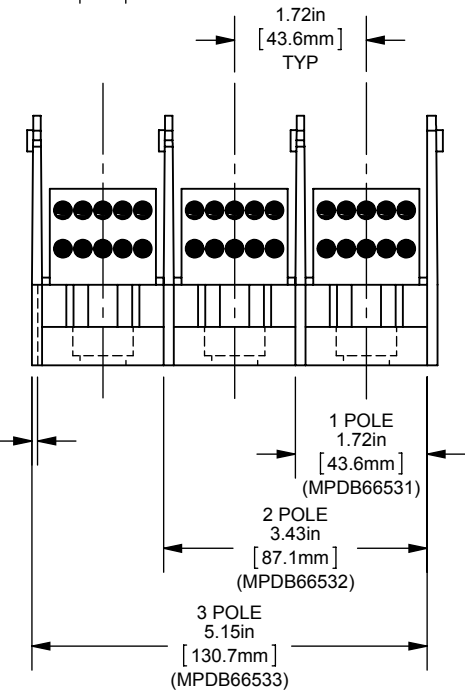
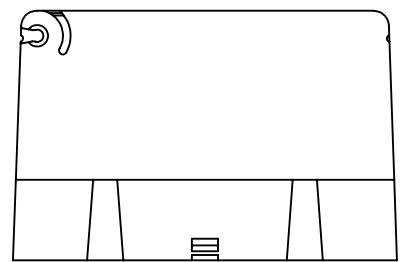
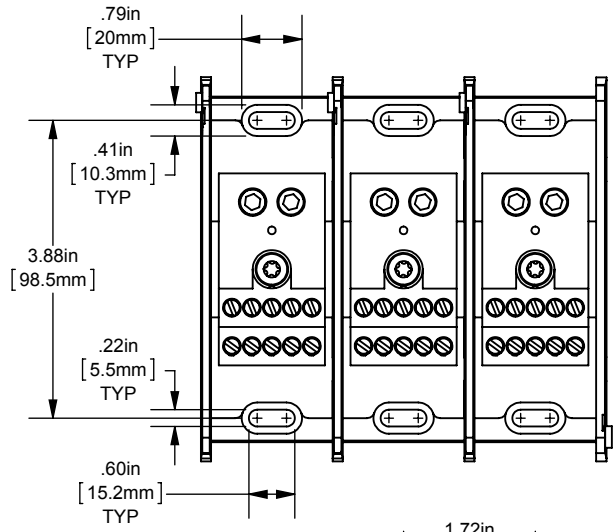

MERSEN USA NEWBURYPORT-MA, LLC
374 MERRIMAC STREET
NEWBURYPORT, MA 01950

MPDB(66530, 66531, 66532, 66533)

PDB 1-3P, ADDER COPPER INTERMEDIATE

(2) 2/0-14 X (10) 6-14

OUTLINE DIMENSIONS
NOT TO BE USED FOR PRODUCTION

702022

PRODUCT MANAGER
SIGN:
DATE:

DESIGN ENGINEER
SIGN:
DATE: (SEE ECO)