

REV.	DATE	ECO	DESCRIPTION	BY	CK	APP
-	9/18/2013	N/A	INITIAL RELEASE	GDR	N/A	N/A

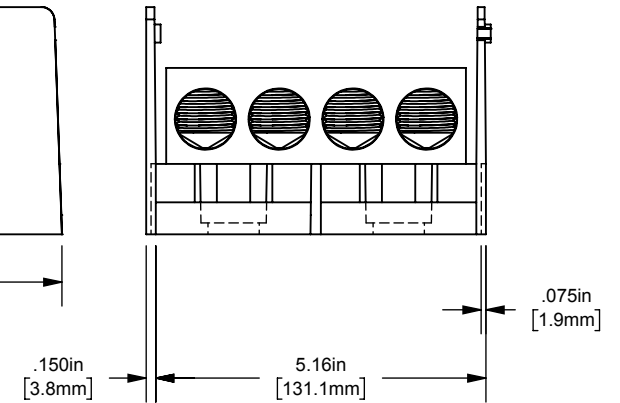

DIMENSIONS IN [] ARE MILLIMETERS

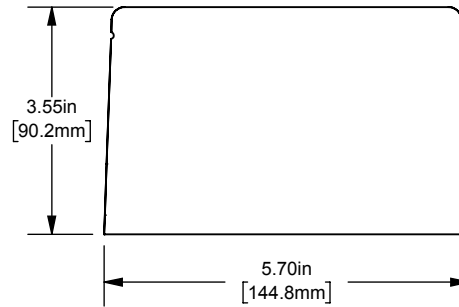
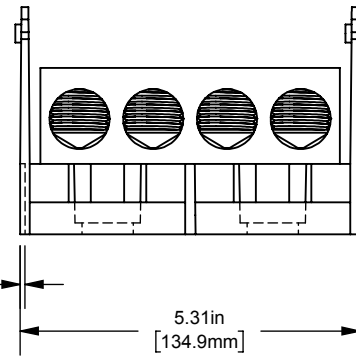
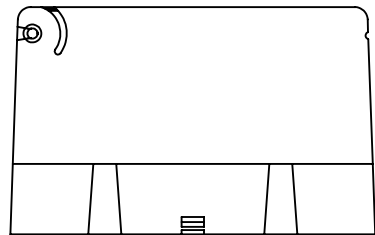
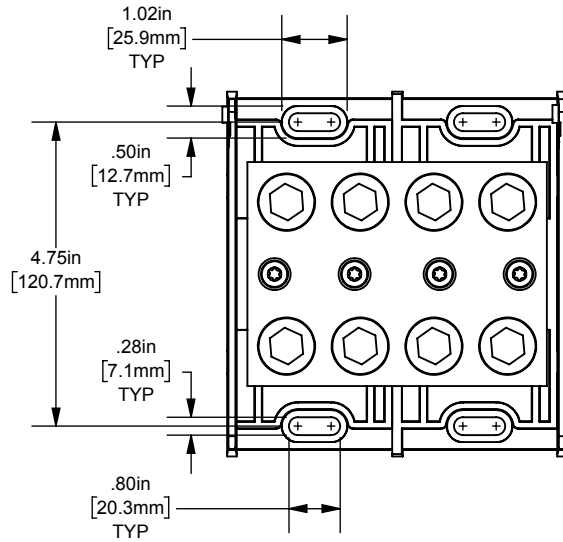

MERSEN USA NEWBURYPORT-MA, LLC
374 MERRIMAC STREET
NEWBURYPORT, MA 01950

MPDB69341

PDB ALUMINUM LARGE DOUBLE WIDE

(4) 600-2 X (4) 600-2

OUTLINE DIMENSIONS
NOT TO BE USED FOR PRODUCTION

702006

PRODUCT MANAGER

SIGN:

DATE:

DESIGN ENGINEER

SIGN:

DATE: (SEE ECO)