

REV.	DATE	ECO	DESCRIPTION	BY	CK	APP
-	8/20/10	N/A	INITIAL RELEASE	RB	NA	N/A

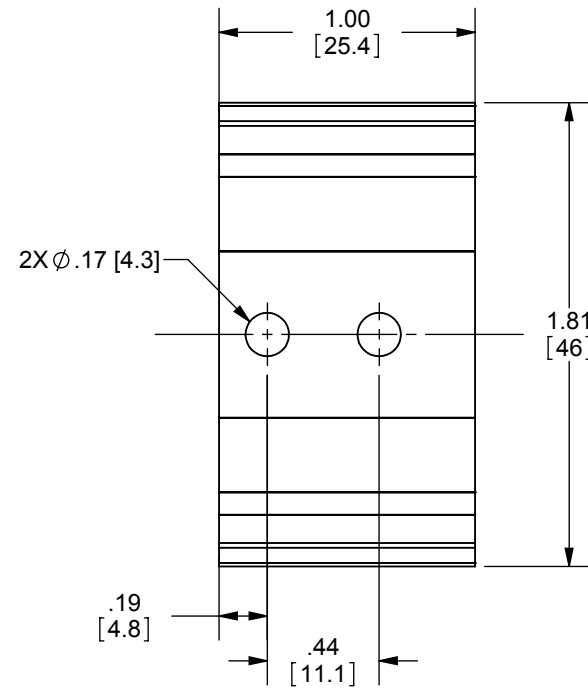

DIMENSIONS IN [] ARE MILLIMETERS

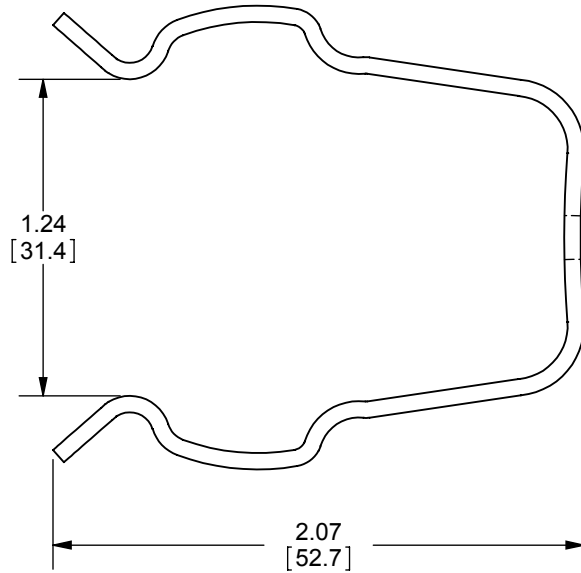

MERSEN USA NEWBURYPORT-MA, LLC
374 MERRIMAC STREET
NEWBURYPORT, MA 01950

9F61AWW632
FUSE SUPPORT PARTS

OUTLINE DIMENSIONS
NOT TO BE USED FOR PRODUCTION

701519

PRODUCT MANAGER

DESIGN ENGINEER

SIGN:

SIGN:

DATE:

DATE: