

REV	DATE	ECO	DESCRIPTION	BY	CK	APP
-	5/14/02	N/A	INITIAL RELEASE	LAS	N/A	N/A

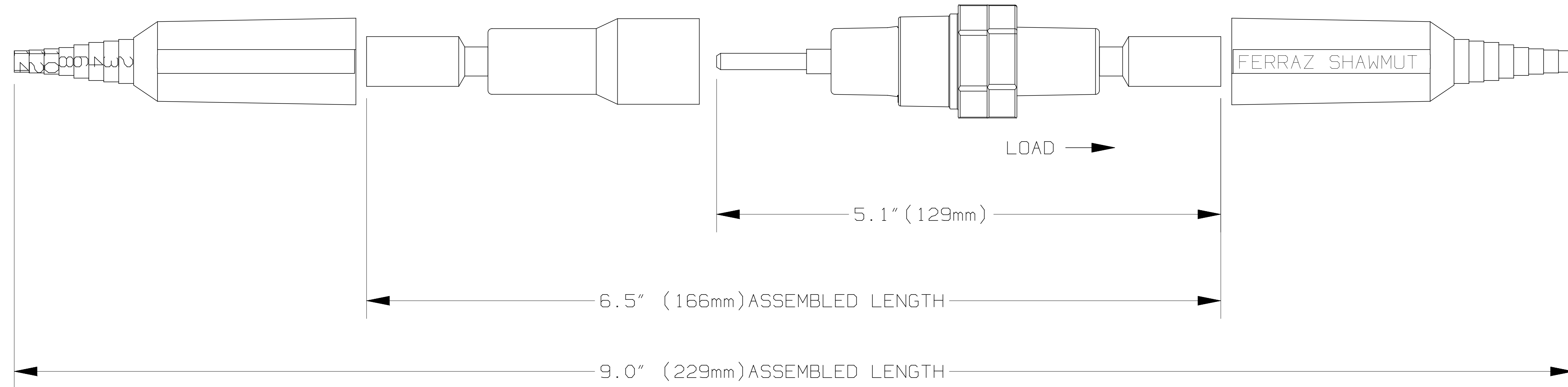

P/N	AMPERE RATING	RMS SYM RATING	CONN TYPE	TORQUE (LBS-IN)	WIRE			UL		CSA	
					WIRE RANGE	°C	TYPE	FILE NO.	GUIDE NO.	FILE NO.	CLASS
FEB-41-41-BA	30	100,000	41-Cu CRIMP	-	{1}#2 STR {2}#6 SOL/STR	75	Cu	E52283	IZLT2	32169	6225



MERSEN USA NEWBURYPORT-MA, LLC
374 MERRIMAC STREET
NEWBURYPORT, MA 01950

FUSE HOLDER, 600V-30A,
1 POLE, IN-LINE,
MIDGET
BREAKAWAY CONFIGURATION

OUTLINE DIMENSIONS
NOT TO BE USED FOR PRODUCTION

700706

PRODUCT MANAGER	DESIGN ENGINEER
SIGN:	SIGN:
DATE:	DATE: